

Petra

*Petra Development & Tourism Region Authority*

*DWELING FOR THE POOR SMALL PROTOTYPE*

*2021*

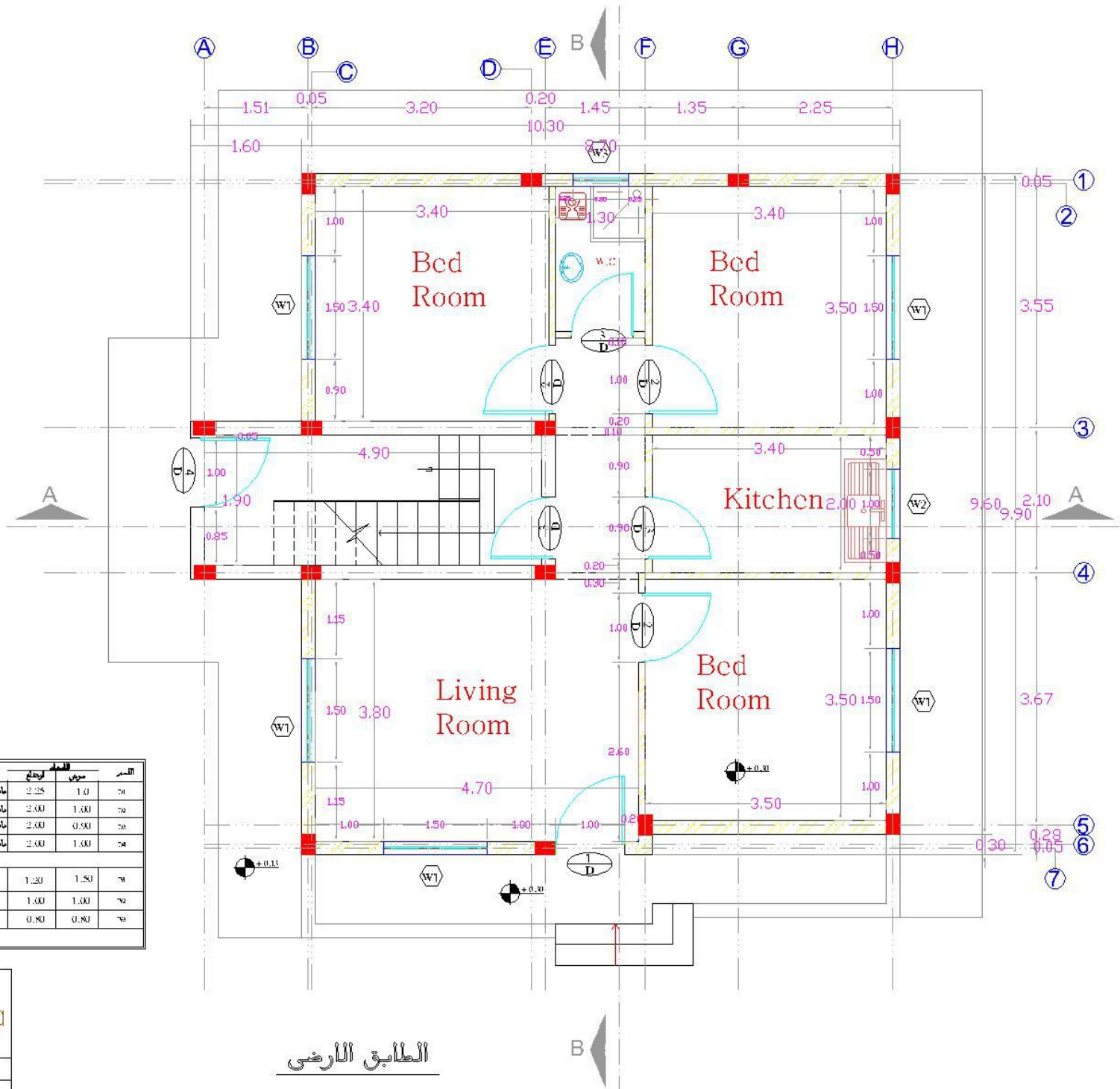

الاسم	حجمي	الارتفاع	ملاحظات
باب عميق خلفه واحد	1.30	2.25	
باب عميق عميق خلفه واحد على حديد	1.00	2.00	
باب عميق عميق خلفه واحد على حديد	0.90	2.00	
باب عميق خلفه واحد	1.00	2.00	
عميلة التصوير سبب معلقين	1.50	1.20	
عميلة التصوير سبب معلقين	1.00	1.00	
عميلة المصيرر غالب ترفه واحد	0.80	0.80	

**Petra**  
 For the Sustainable Development of the Built Environment

Architectural plan

Scale: 1/50

Date: 2014

Drawn by: Eng. Hisham Al-Bassal

الطابق الارضي



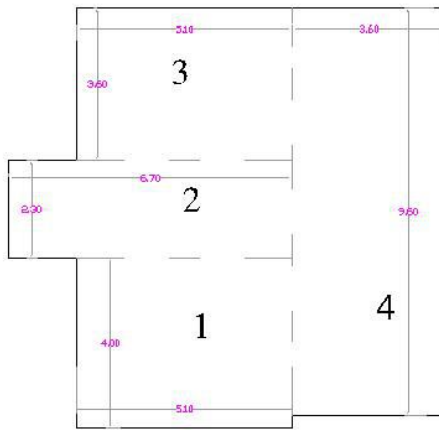

الغرفة	المساحة (م <sup>2</sup> )	العدد	المساحة (م <sup>2</sup> )
1	20.6	5.30	28.00
2	15.71	6.70	2.30
3	14.36	3.10	3.60
4	37.36	3.60	9.60
مكرر الدرج	12.19	5.30	2.30
المساحة الكلية		[ 8 ] 101	

تسطير الطابق الأرضي

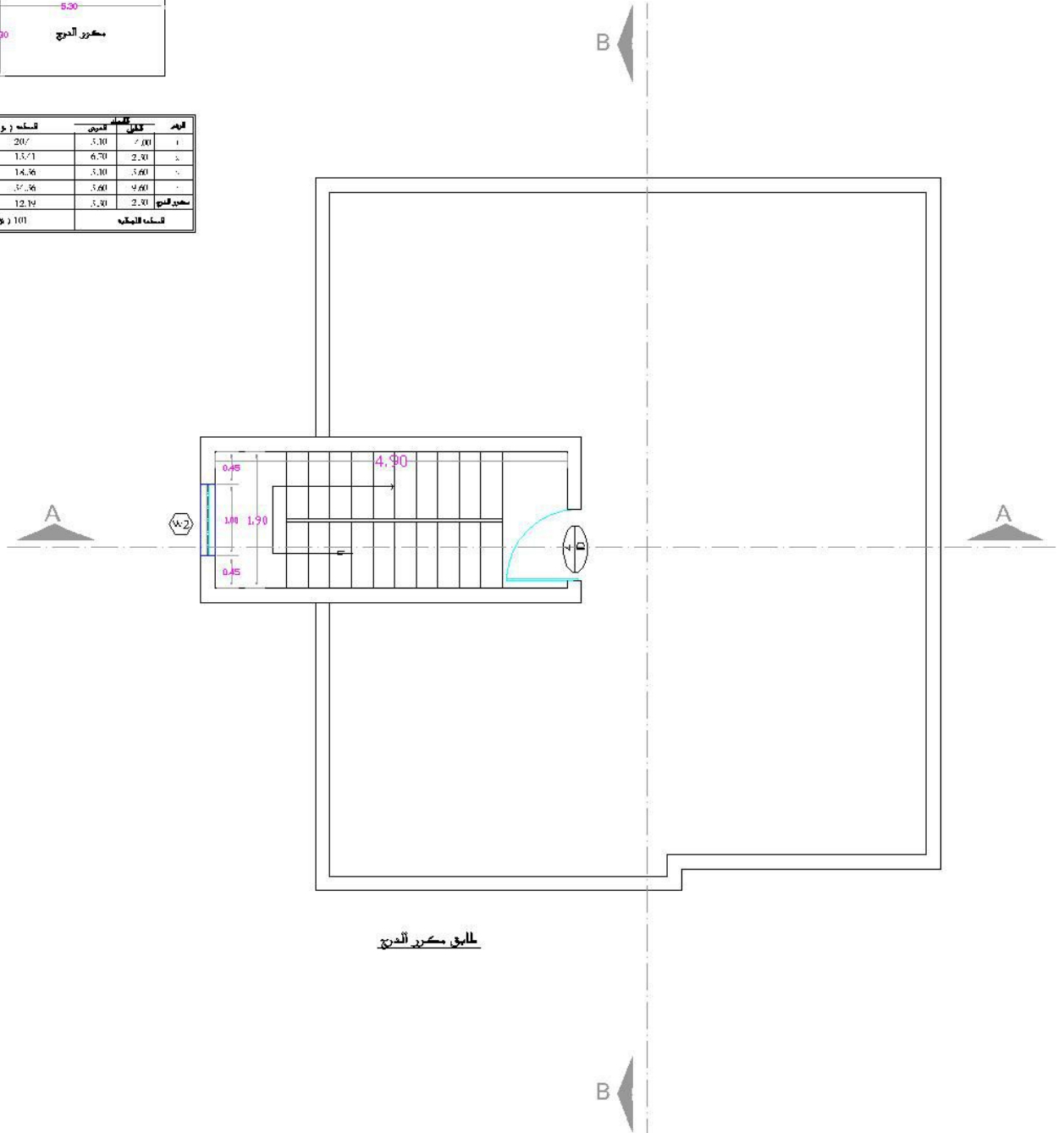

مكرر الدرج



المساحة الكلية	
المساحة الكلية	
المساحة الكلية	المساحة الكلية
المساحة الكلية	المساحة الكلية
المساحة الكلية	المساحة الكلية

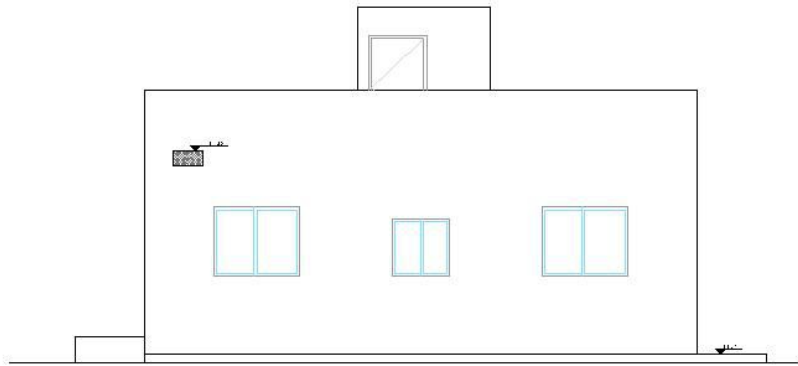

Side Elevation

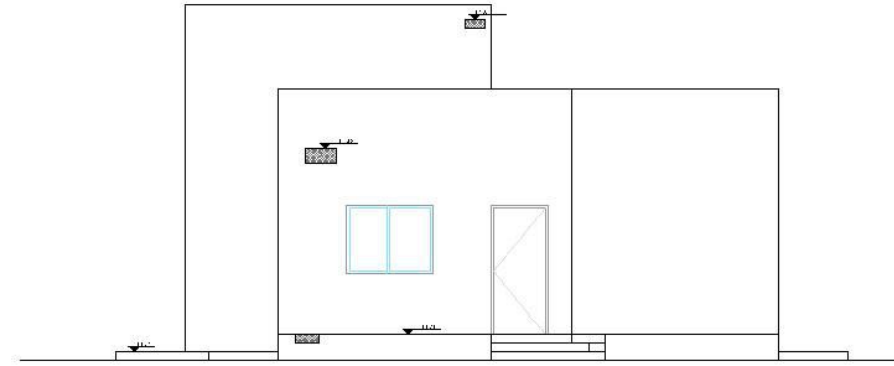

Front Elevation

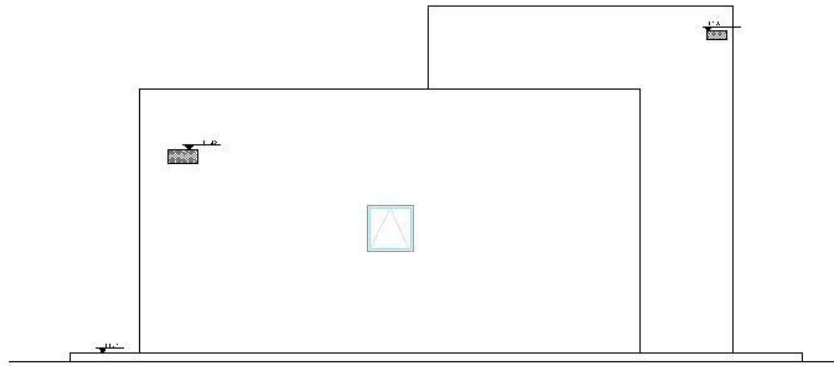

Back Elevation

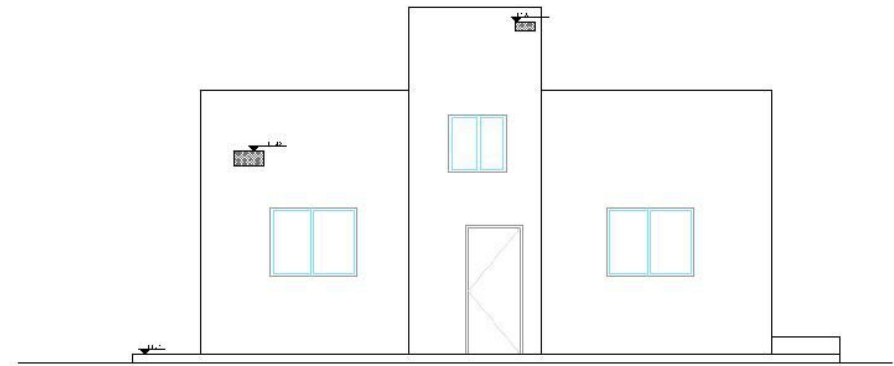

Side Elevation

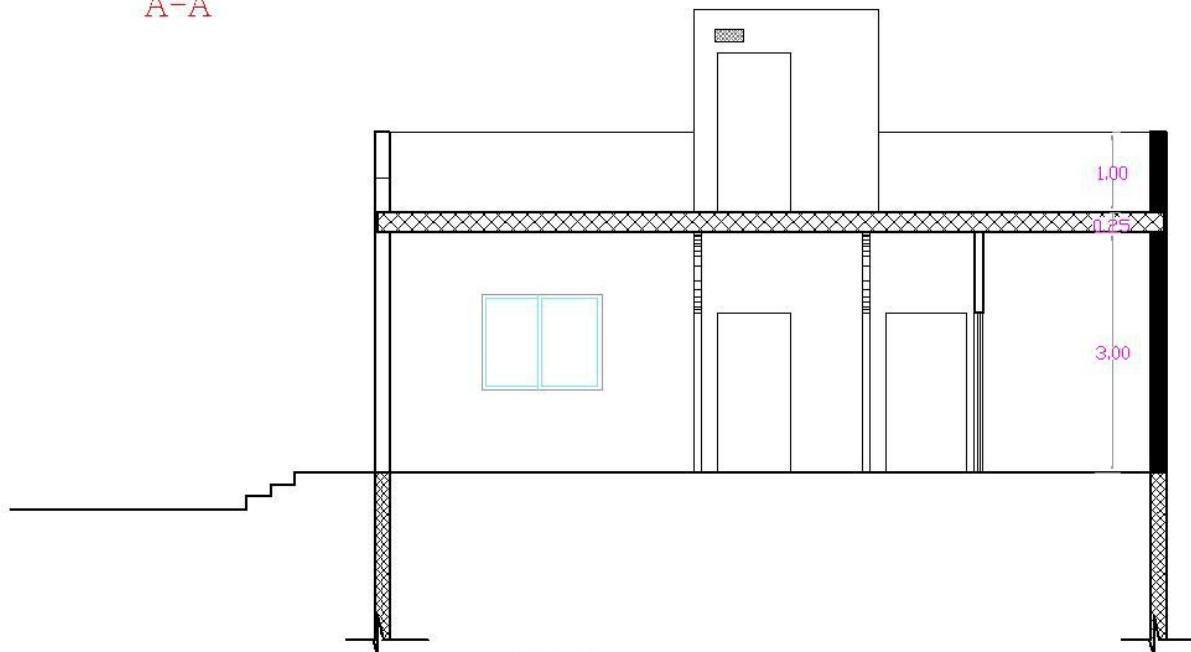
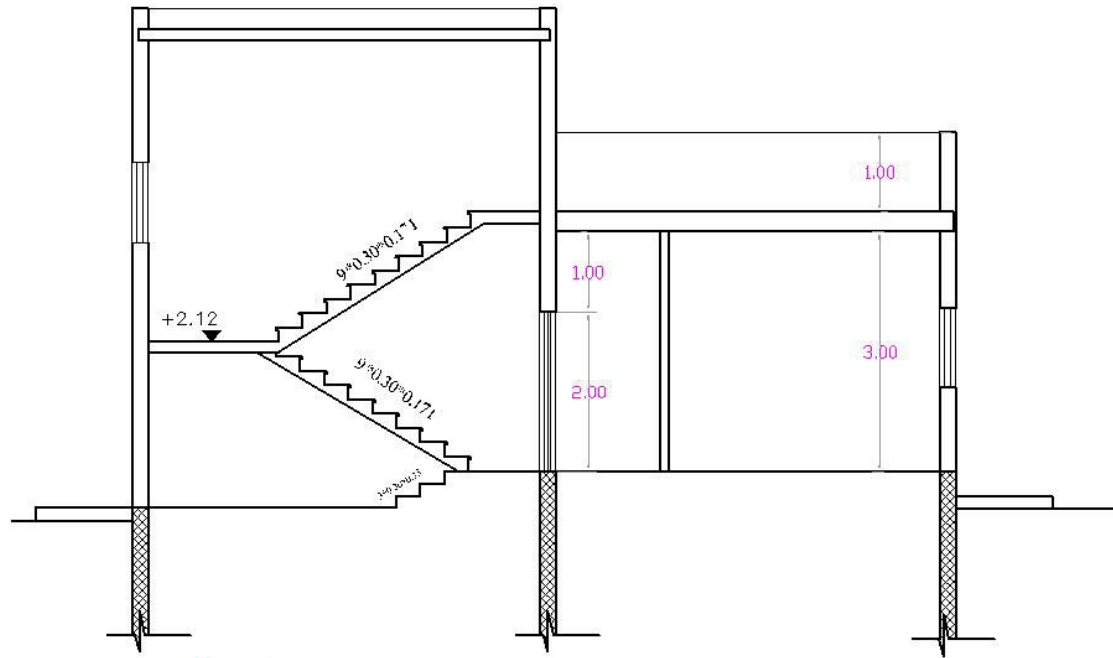





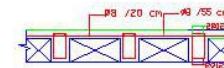
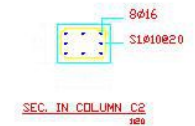
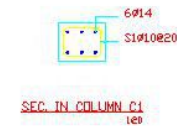
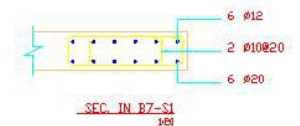
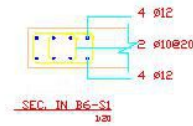
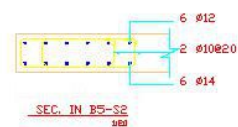
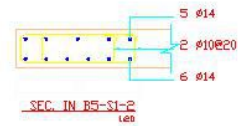
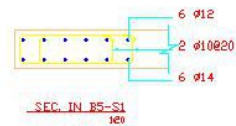
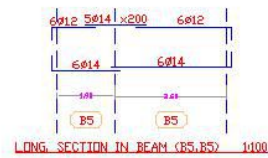
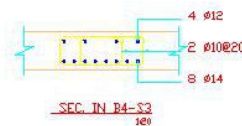
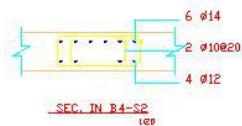
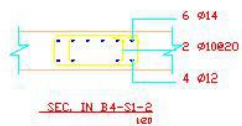
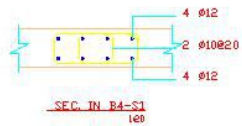



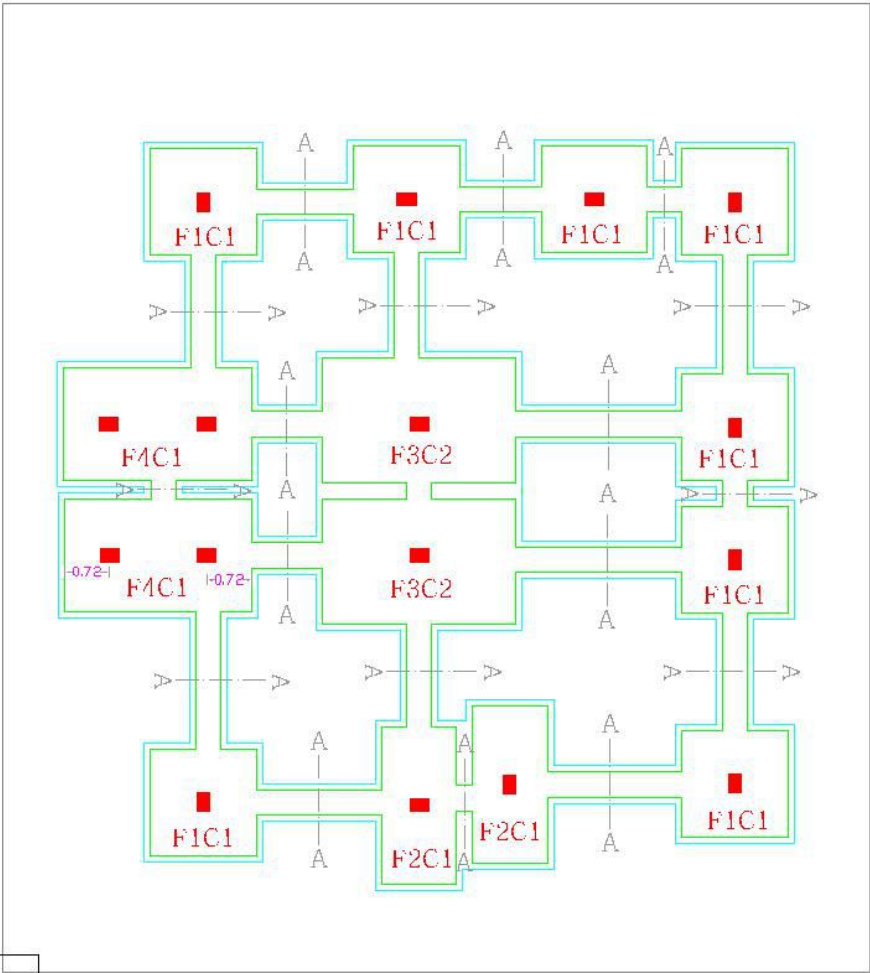
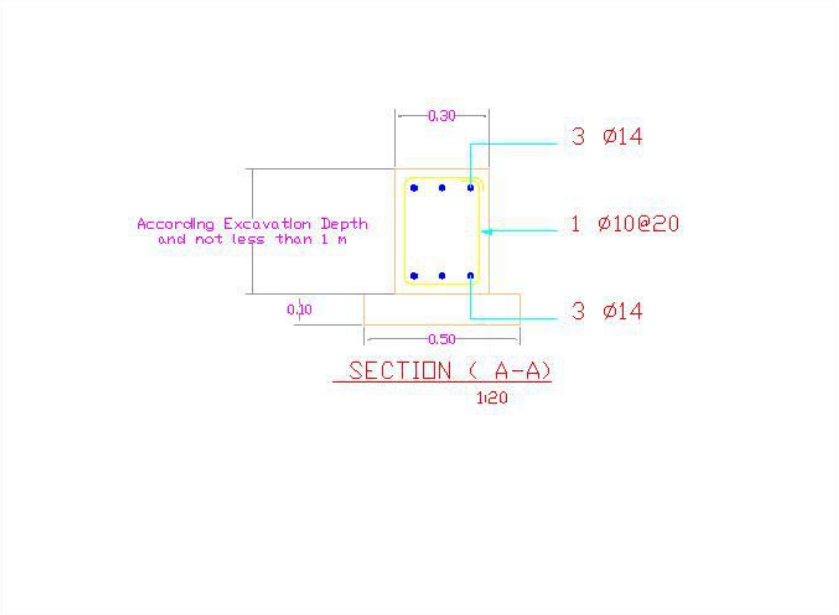

Project Name	Site plan
Client	...
Scale	1:50
Author	Eng. Mohamed Al-Sayid

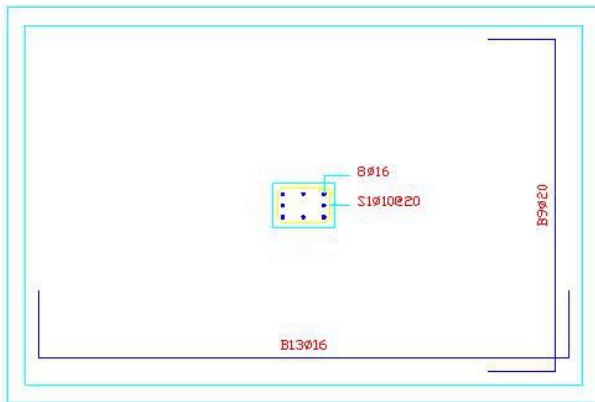
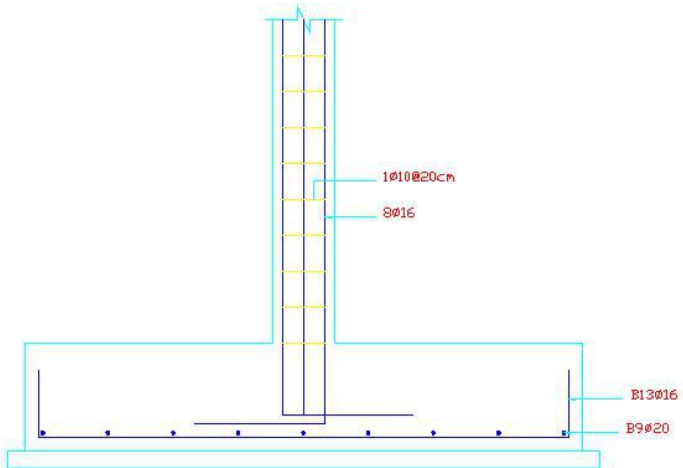

SEC. IN F3C2  
1/20

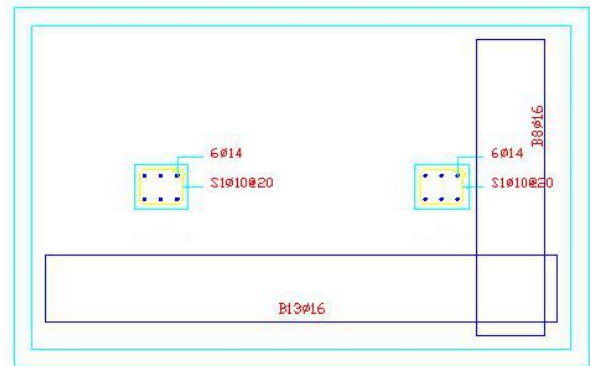
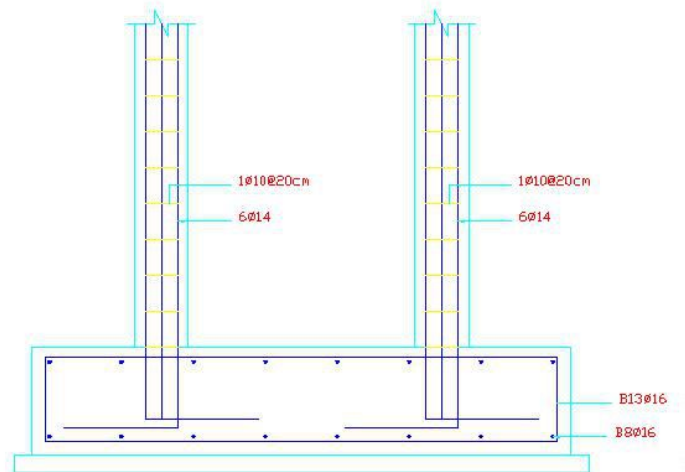

SEC. IN F4C1  
1/20

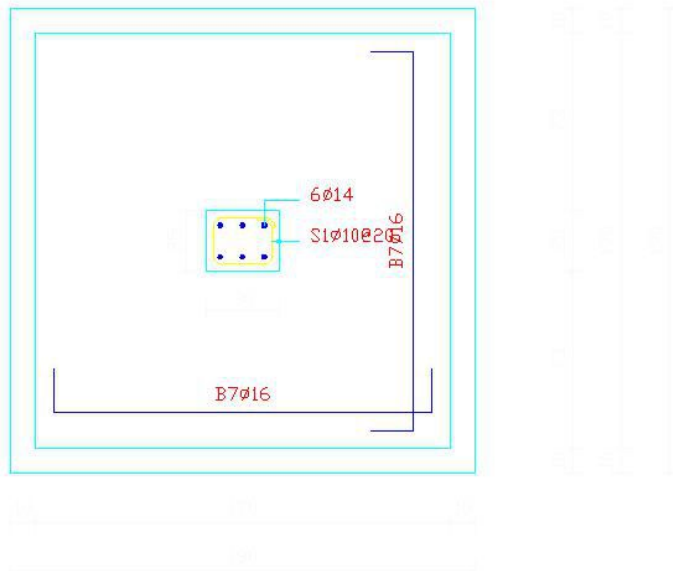
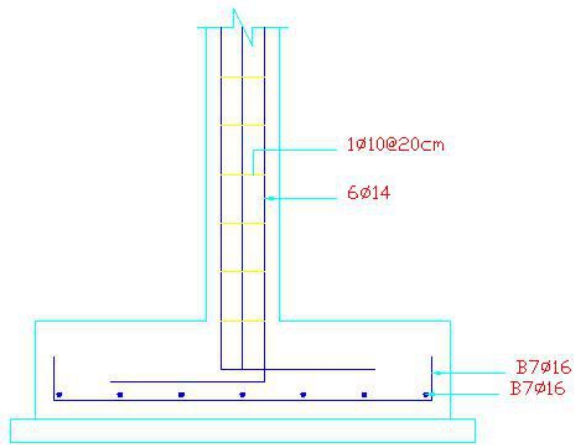

SEC. IN F1C1  
1:20

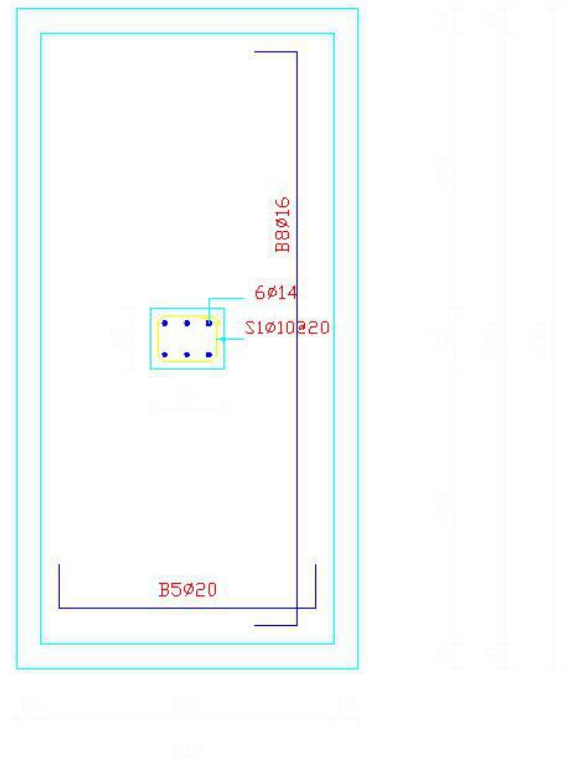
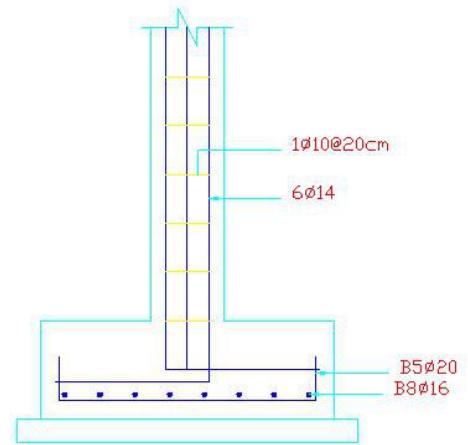

SEC. IN F2C1  
1:20

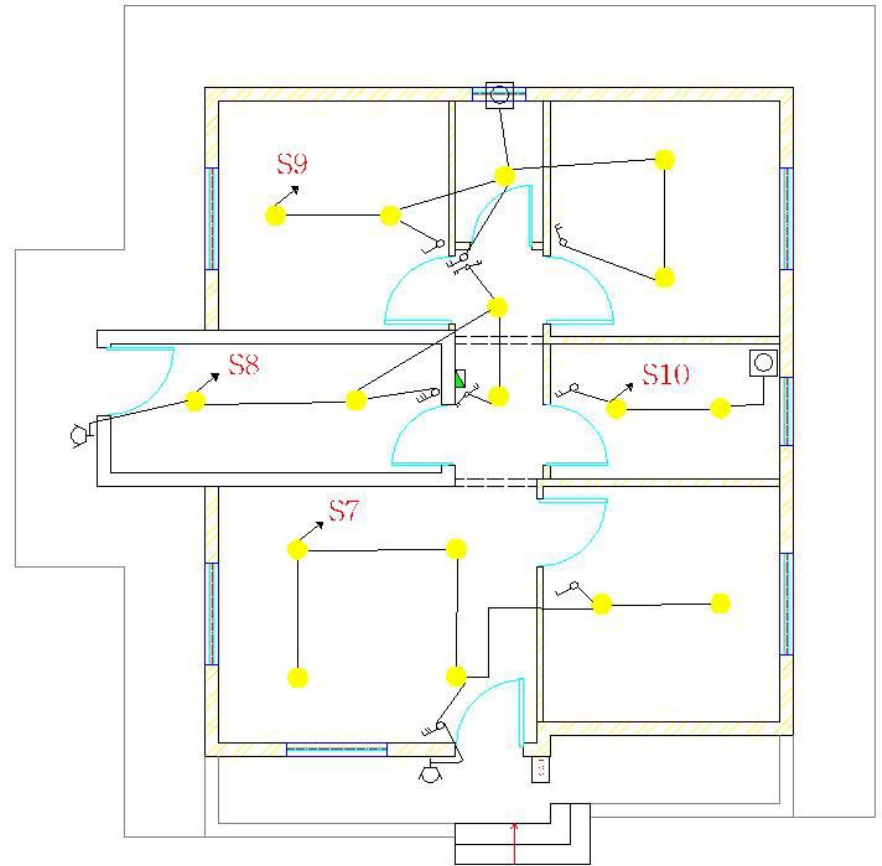
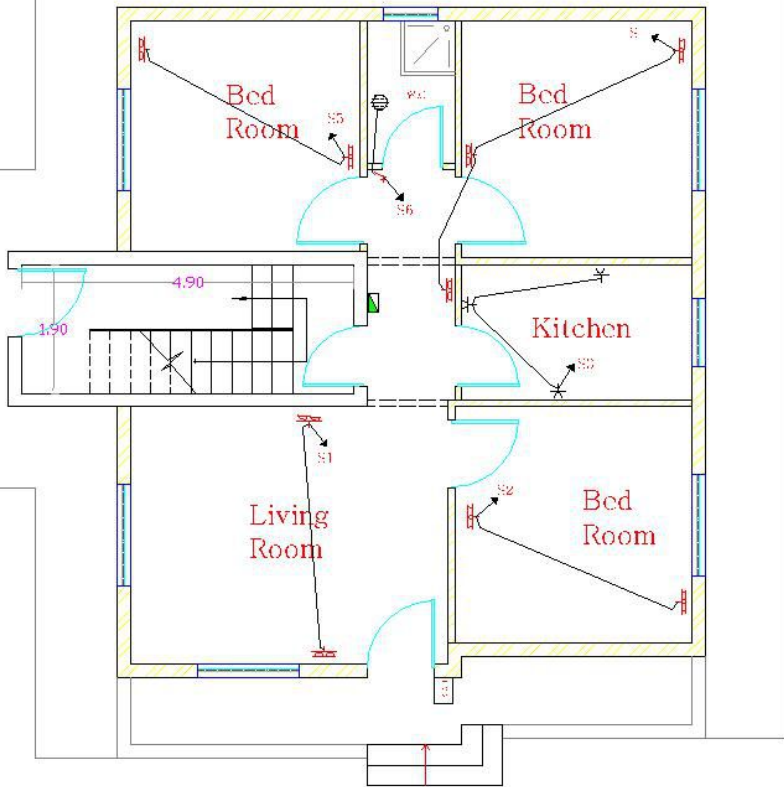

SYMBOL	DESCRIPTION
	13A, SINGLE PHASE SOCKET OUTLET, WITH EARTHING POLE, WATERPROOF, POWER SOCKET.
	(LED) LIGHTING POINT, CEILINGS MOUNTED (20-23W) .
	10A, THREE GANG-ONE WAY SWITCH .
	10A, ONE GANG - ONE WAY SWITCH .
	10A, TWO GANG-ONE WAY SWITCH .
	DISTRIBUTION ELECTRIC BOARD .
	(30-WATT, LED LIGHTING , WALL MOUNTED OUT-DOOR.
	FAN .
	13A, SINGLE PHASE SOCKET OUTLET, WITH EARTHING POLE,POWER SOCKET.
	15A, TWIN POLE - ONE WAY SWITCH, WITH PILOT LAMP.
	WATER HEATER 1500W .

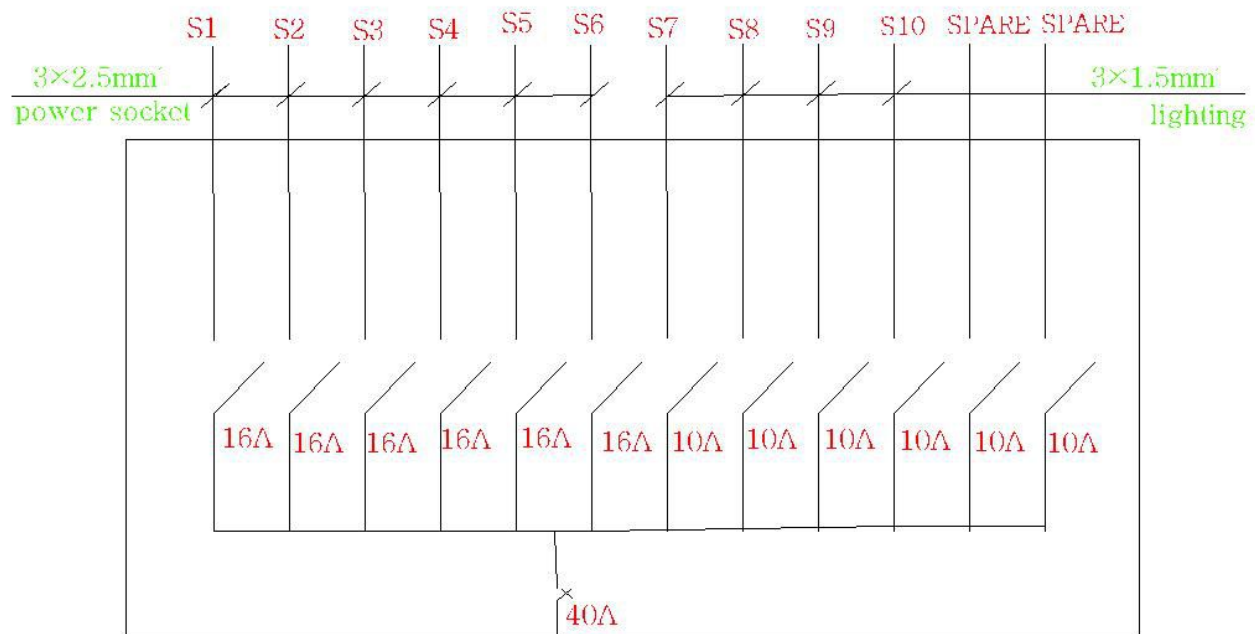

قجول زومر رصان علأ قئى اب رملأ



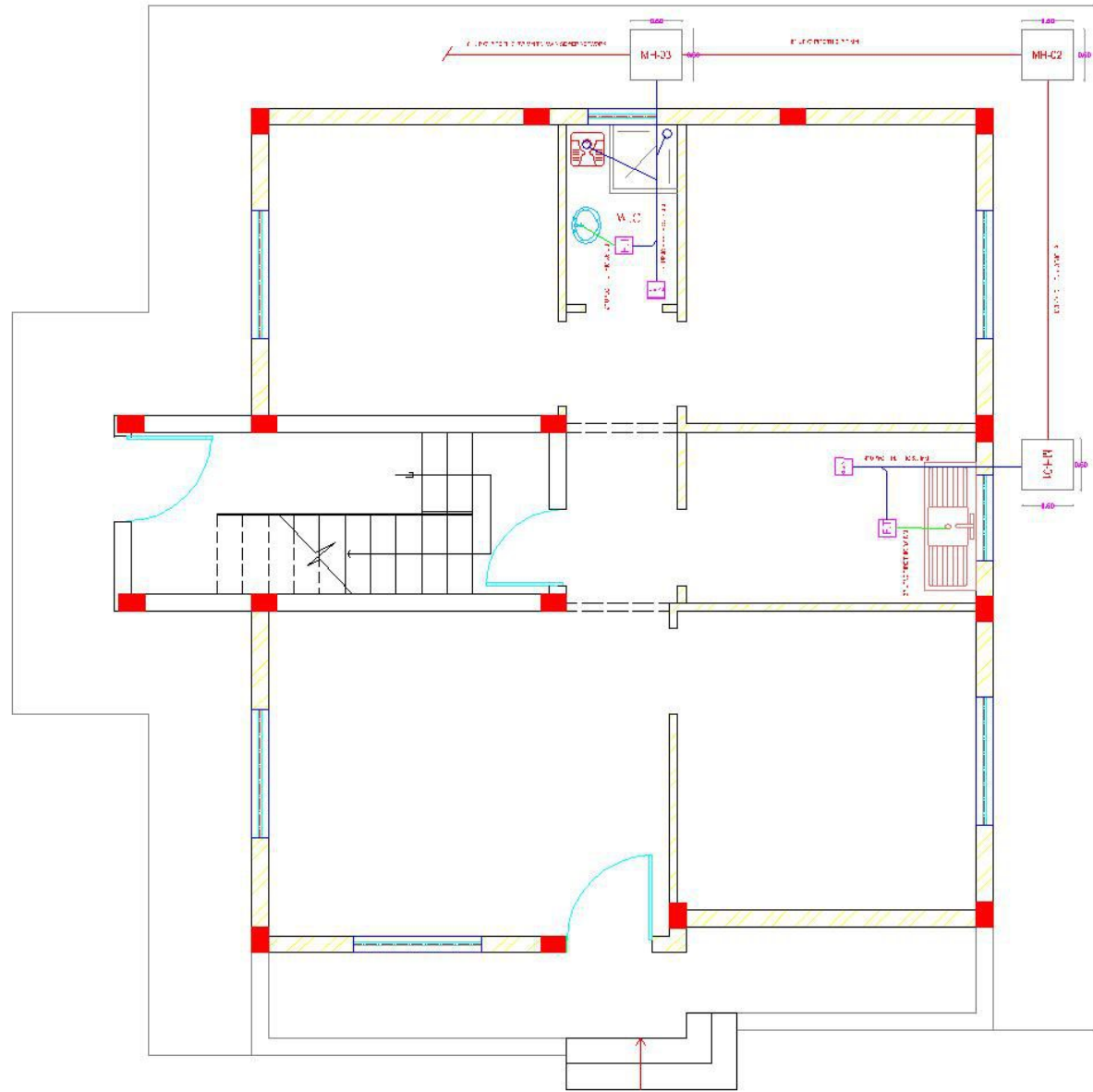

الطابق الارضى

مخطط التمديدات الصحية

اسم المشروع Subsidiary plan	
رقم المخطط	رقم المخطط
2008	2008
2008	2008

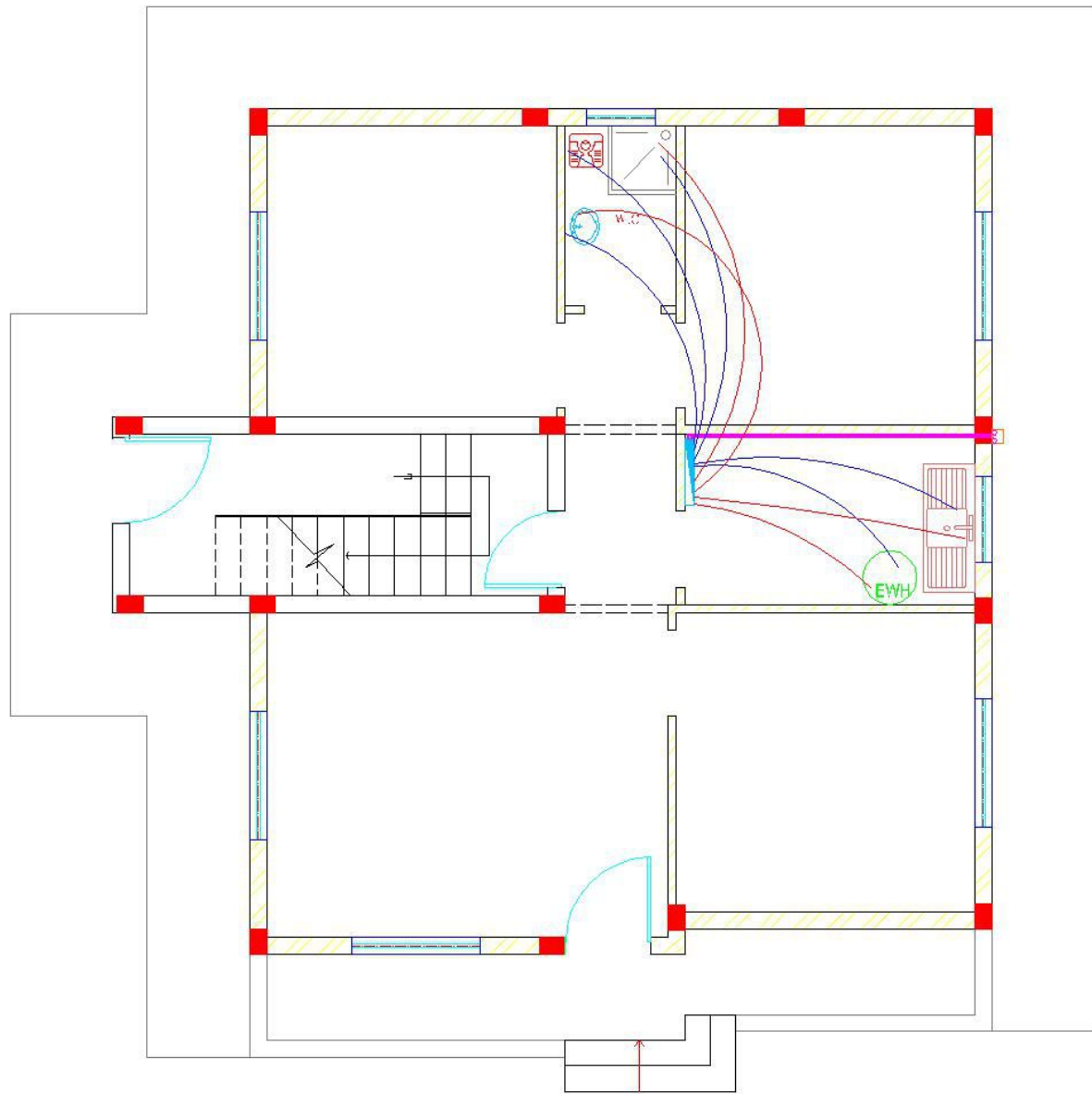

## مخطط تمديدات المياه

**Petra**  
 For all construction & architectural works

Project Name	Subsidiary plan
Scale	1:50
Date	20/10/2023

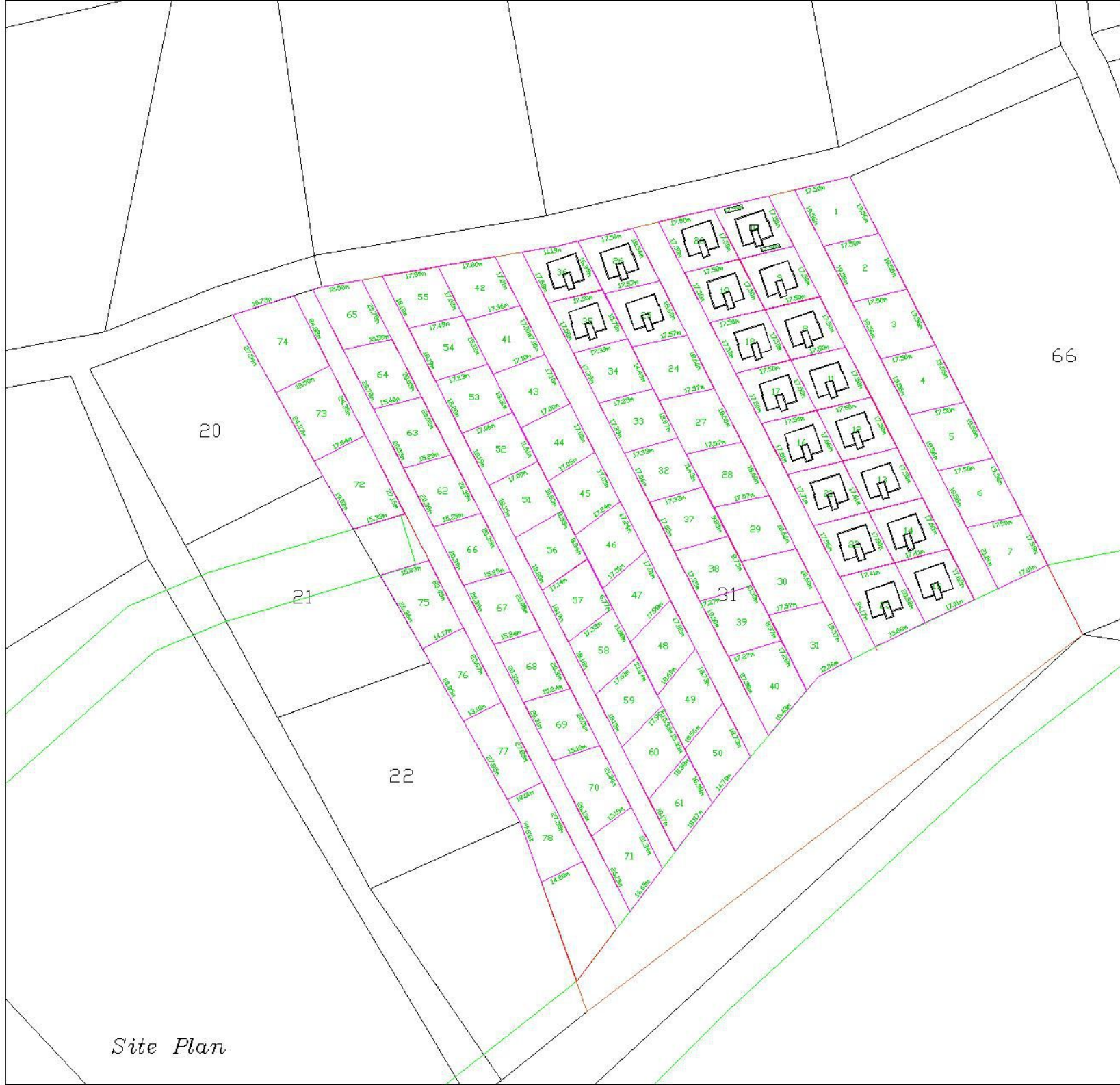

Site Plan